



H BUMPER

All Makes Catalog
Popular Part Numbers

H HENDRICKSON

The World Rides On Us®



See us on the web at

www.hendricksonbumper.com

SELECTION TOOL

CROSS REFERENCE TOOL

BUMPER LITERATURE



Additional product listings are only a click away!

Check out our Selection and Cross Reference Tools and browse our current literature.

If you can't find what you need, please call Customer Service at 800.356.6737.

We want to hear from you!



WELCOME TO THE **HENDRICKSON** ALL MAKES BUMPER PROGRAM

Hendrickson is the leading tier one OEM supplier of heavy duty truck bumpers for the North American commercial vehicle industry. Our commitment to quality and product innovation drives this industry leadership position, thus promoting the development of products that enhance vehicle styling and durability. Key capabilities, which include proprietary bumper forming technology and advanced metal and plastic materials, enable Hendrickson to manufacture aerodynamically contoured bumper designs that are durable yet lightweight. Hendrickson supplies over 1,000 different part numbers from chrome plated steel, prime painted bumpers and many proprietary products.

Hendrickson has an extensive field sales, parts and service organization to support our customers around the globe — truck owners, dealers, fleets, and OEMs. Our investment in new technologies will continue as we strive to deliver customers more value. At Hendrickson, innovation never rests.

TABLE OF CONTENTS

Bumper Materials and Technology	2
Understanding the Hendrickson All Makes Bumper Program	3
Ford	4
Freightliner	5
International	12
Kenworth	16
Mack	21
Peterbilt	25
Volvo	28
Western Star	30
Blank	31
Air Dams	32

BUMPER PRODUCTS AND TECHNOLOGY



AERO CLAD® Stainless Steel Clad Aluminum

- Durable, bright mirrored finish
- Finish 10 times thicker than chrome
- Resists corrosion
- Resists cracking, pitting, peeling and fading
- Lightweight for better fuel economy
- Minor abrasions can be buffed
- Full five-year limited warranty*



AERO GUARD™ Bumper Technology

- Improved cold impact durability
- Lightweight aerodynamic design
- Molded-in-black textured finish
- Increased ground clearance
- Improved cooling air flow capacity



Steel Chrome

- One-year limited warranty*
- Available in 7-gauge or 10-gauge steel
- Bright mirrored finish
- Many shapes available
- Customize your bumper with cutouts and roadlights
- Competitive pricing
- Also available in corrosion resistant E-coat finish, ready for top coat



Solid Stainless Steel

- Full five-year limited warranty*
- Bright mirrored finish
- Resists corrosion
- Resists cracks, peeling rust and fading
- As durable as a steel bumper
- Minor abrasions can be buffed

* Visit our website at www.hendricksonbumper.com or call 800.356.6737 for complete warranty terms, conditions and limitations.



UNDERSTANDING THE HENDRICKSON ALL MAKES BUMPER PROGRAM

PART NUMBERING SYSTEM

Part Type:

100 - 199 Ford
200 - 299 Freightliner
300 - 399 GMC
400 - 499 International
500 - 599 Kenworth
600 - 699 Mack
700 - 799 Blank
800 - 899 Peterbilt
900 - 903 Volvo
904 - 911 Western Star

Material Thickness:

0 = Ten Gauge Steel
7 = Seven Gauge Steel

Road Light Sizes:

Millennium Lights Available
Oval is 6.75" x 2.75" with 1.375" radius on ends
Round is 2.31" diameter

Material Abbreviations:

SQ = Texas Square
SSC = Stainless Steel Clad Aluminum
SSCSQ = Stainless Steel Clad Aluminum
Texas Square
STQ = Solid Stainless Steel Texas Square
AG = AERO GUARD™
BRT = HENDRICKSON AERO BRIGHT®

Example: Part #0100SQ

0 = Ten gauge steel
100 = Ford
SQ = Texas Square

ORDER/REORDER REQUIREMENTS

Direct Questions to Hendrickson
Customer Service at 1-800-356-6737,
or OEM Customer Service Division.

FREIGHT POLICY

Direct Questions to Hendrickson
Customer Service at 1-800-356-6737,
or OEM Customer Service Division.

INQUIRIES

Questions regarding literature, order
status and product information may be
directed to Hendrickson Customer Service
at 1-800-356-6737, or OEM Customer
Service Division.

WARRANTY AND RETURN POLICY

Steel Chrome: 1 year from date of sale for
materials and workmanship. Direct questions
to your OEM claims administrator.

AERO CLAD®: 5 years from date of sale.
Direct questions to your OEM claims
administrator.

Solid Stainless Steel: 5 years from date of
sale. Direct questions to your OEM claims
administrator.

AERO GUARD™: 2 years from service date
for parts and labor. Direct questions to your
OEM claims administrator.

FORD

LN/LT/LTN/LTL/8000/9000

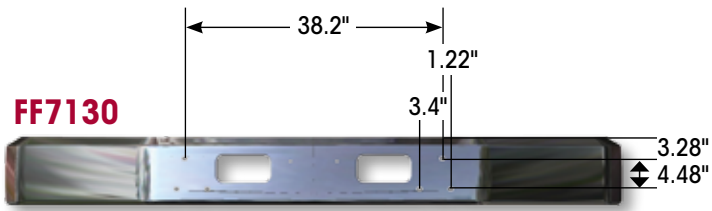

FF7130
Ford OEM 8000 and 9000 Batwing Aero — 1988 and above.
FF7131 has bolt holes for air dam.

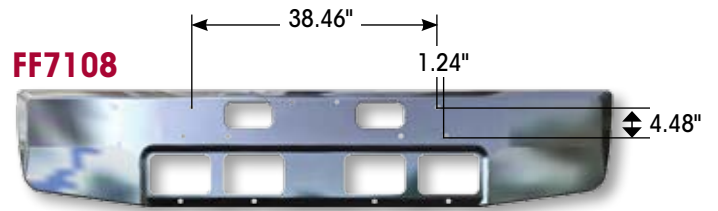

FF7108
Ford OEM LTL 9000

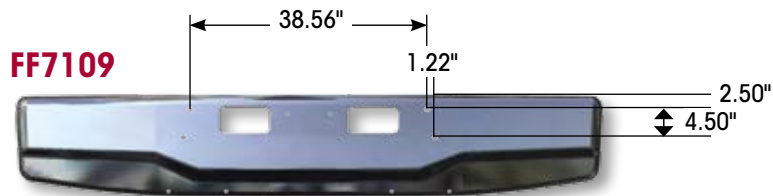

FF7109
Ford OEM L-Series 8000 and 9000 — 1987 and above

PART NUMBER	MATERIAL / FINISH	EXCLUSIVE	GAUGE	STYLE	LIGHT	CENTER STEP	VENT	TOW	MOUNTING ONLY	VORAD
FF7130	Chrome	FL	7	Setback Batwing				X		
FF7108	Chrome	FL	7	16" Taper	4 Square	X		X		
FF7109	Chrome	FL	7	Corporate Face				X		

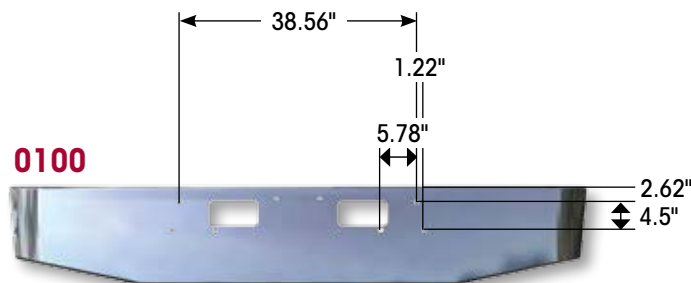

0100
Ford L-Series conventional fits LN-LT-LTN 800, 900, 8000 and 9000 (Tow holes only). Fits trucks with 6V92 Detroit engine or 300 Cummins engine 1988 or newer (Axle forward only).

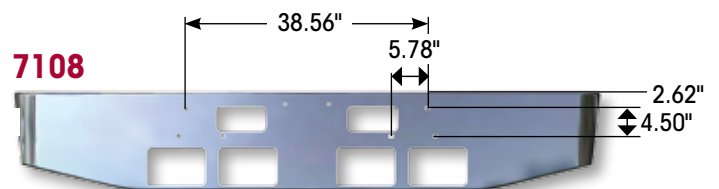

7108
Ford Conventional LTL 9000 — Step holes and four square light holes

PART NUMBER	MATERIAL / FINISH	EXCLUSIVE	GAUGE	STYLE	LIGHT	CENTER STEP	VENT	TOW	MOUNTING ONLY	VORAD
0100	Chrome		10	16" Taper				X		
0101	Chrome		10	16" Taper	2 Round			X		
7100	Chrome		7	16" Taper				X		
7108	Chrome		7	16" Taper	4 Square			X		



FREIGHTLINER

FLC

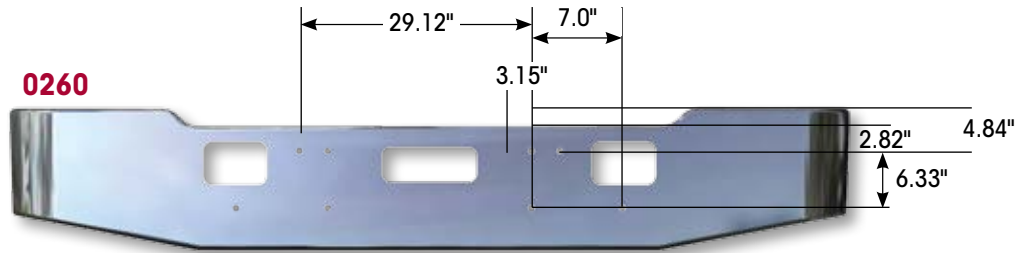

Freightliner FLC-112 — SA with vent and tow holes

PART NUMBER	MATERIAL / FINISH	EXCLUSIVE	GAUGE	STYLE	LIGHT	CENTER STEP	VENT	TOW	MOUNTING ONLY	VORAD
0260	Chrome		10	16" Gullwing		X		X		
0261	Chrome		10	16" Gullwing	2 Square	X		X		

FLD

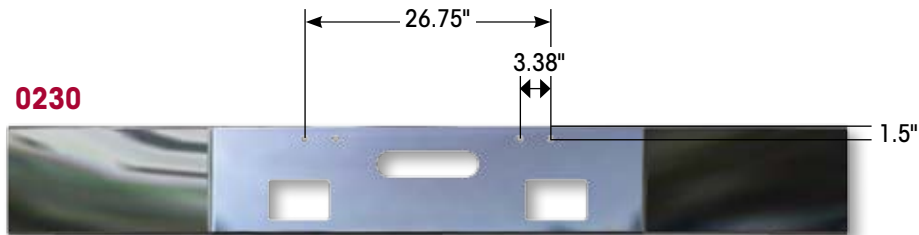

Freightliner set back axle — Fits FLD 120 — Severe Duty Construction

PART NUMBER	MATERIAL / FINISH	EXCLUSIVE	GAUGE	STYLE	LIGHT	CENTER STEP	VENT	TOW	MOUNTING ONLY	VORAD
0230	Chrome		10	12" Set Back	2 Square	X				
7230	Chrome		7	12" Set Back	2 Square	X				
7240	Chrome		7	12" Set Forward	2 Square	X		X		

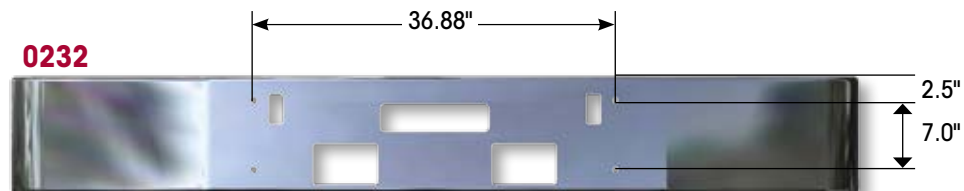

Freightliner FLD 112 — SA with 12" set back axle

PART NUMBER	MATERIAL / FINISH	EXCLUSIVE	GAUGE	STYLE	LIGHT	CENTER STEP	VENT	TOW	MOUNTING ONLY	VORAD
0232	Chrome		10	12" Set Back	2 Square	X		X		
7233	Chrome		7	12" Set Forward	2 Square	X		X		

FREIGHTLINER

FLD cont.

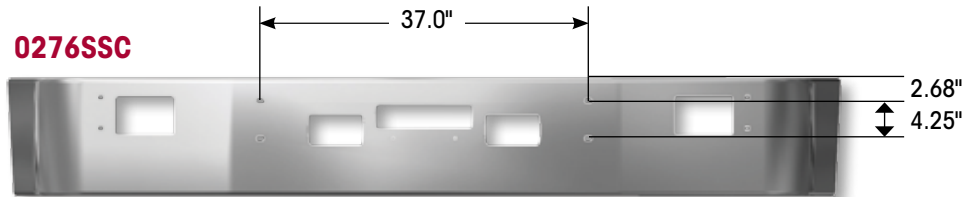

Freightliner FLD 120 — 1989 and newer

PART NUMBER	MATERIAL / FINISH	EXCLUSIVE	GAUGE	STYLE	LIGHT	CENTER STEP	VENT	TOW	MOUNTING ONLY	VORAD
0279BX	Steel Primed		10	12" Set Back				X		
0275BX	Steel Primed		10	12" Set Back		X		X		
0276BX	Steel Primed		10	12" Set Back	2 Square	X		X		
0279SSC*	AERO CLAD®		10	12" Set Back SSC				X		
0275SSC*	AERO CLAD		10	12" Set Back SSC		X		X		
0276SSC*	AERO CLAD		10	12" Set Back SSC	2 Square	X		X		

*Braces and Spacers included with bumper

For models fitted with Perlex drive lights, use Freightliner back-up bar P/N A21-20133-003.

For models fitted with Marchel drive lights, use Freightliner back-up bar P/N A21-20133-000.

NOTE: The SSC FLD Bumper requires the Freightliner back-up bar for assembly. The back-up bar is standard with all plastic bumper applications. The back-up bar is not standard with metal bumper applications.

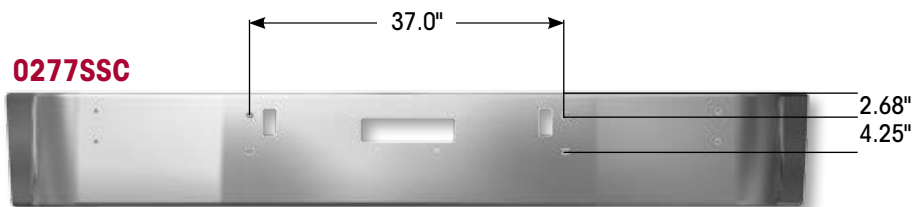

Freightliner FLD 112 with step and tow holes

PART NUMBER	MATERIAL / FINISH	EXCLUSIVE	GAUGE	STYLE	LIGHT	CENTER STEP	VENT	TOW	MOUNTING ONLY	VORAD
0277B**	Steel Primed		10	12" Set Back		X		X		
0277SSC*	AERO CLAD		10	12" Set Back SSC		X		X		
0278SSC*	AERO CLAD		10	12" Set Back SSC	2 Square	X		X		

*Braces and Spacers included with bumper

**IH Dealers use AM0277BX



FREIGHTLINER

BUSINESS CLASS

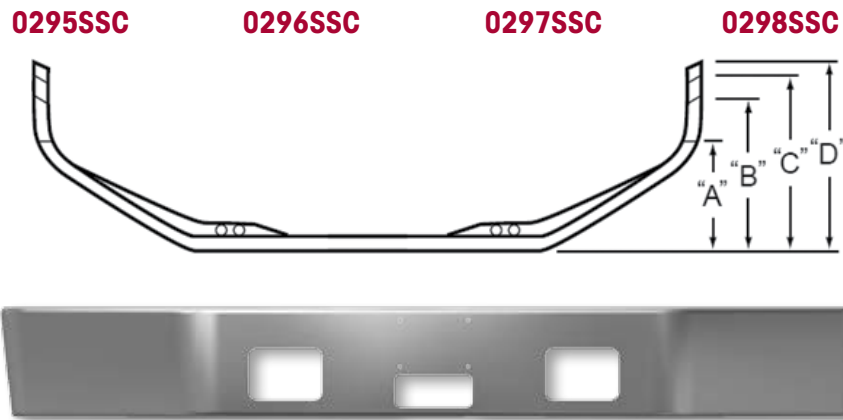

Freightliner stainless steel clad aluminum fits Business Class — Includes brackets (Installed)

PART NUMBER	MODEL	LEG	DIMENSION
0296SSC	FL50, 60, 70, 80, 106	A	14.2"
0295SSC	FL50, 60, 70, 80, 106	B	21.3"
0297SSC	FL112	C	23.5"
0298SSC	FL112	D	25.5"

CENTURY CLASS

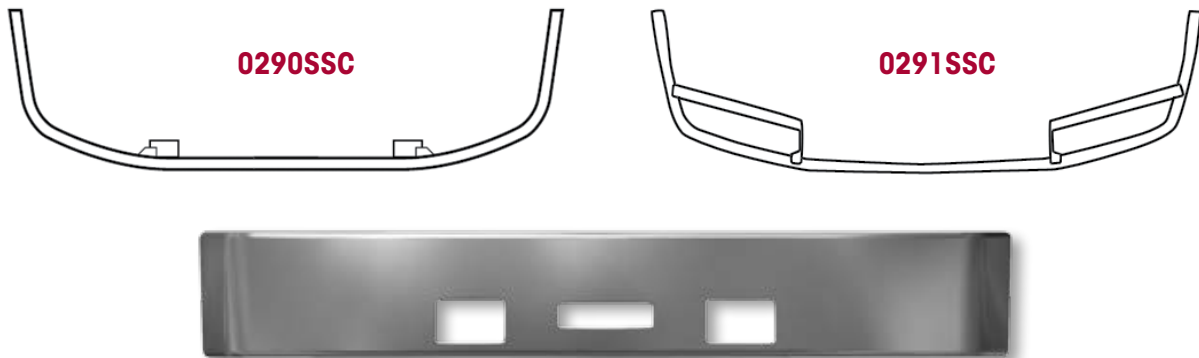

Freightliner Century Class stainless steel clad aluminum — Includes brackets (Installed)

PART NUMBER	MATERIAL / FINISH	EXCLUSIVE	GAUGE	STYLE	LIGHT	CENTER STEP	VENT	TOW	MOUNTING ONLY	VORAD
0290SSC (Pre 2004)	AERO CLAD®		10	12" Set Back SSC		X		X		
0291SSC (Post 2004)	AERO CLAD		10	12" Set Back SSC		X		X		

Required hardware to install bumper:

Mounting Bracket (P/N: A21-25693-000 LH & A21-25693-001 RH) and Spacer (2 required, P/N: 23-11427-038) available from your Freightliner dealer. Drill 14mm hole in top mounting bracket for pre-1997 Century Class.



FREIGHTLINER

COLUMBIA

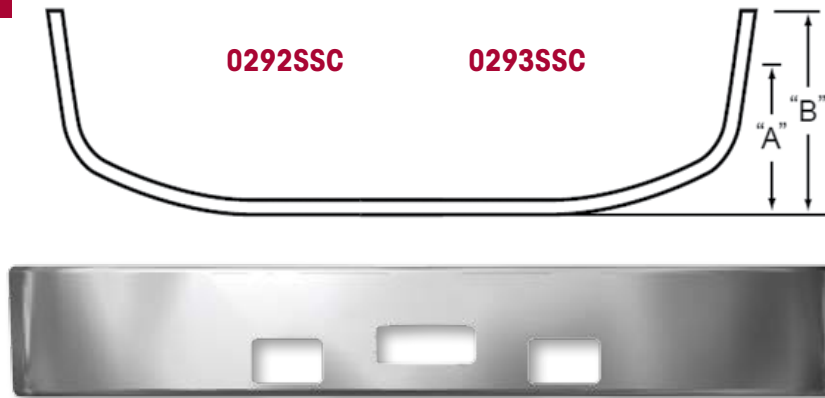

Freightliner Columbia stainless steel clad aluminum

PART NUMBER	LEG	DIMENSION
0292SSC*	A	25.15"
0293SSC**	B	28.34"

*When replacing factory bumper you must refer to Freightliner Bill of Material T80133.

**When replacing factory bumper you must refer to Freightliner Bill of Material T80132.

FLD-CLASSIC

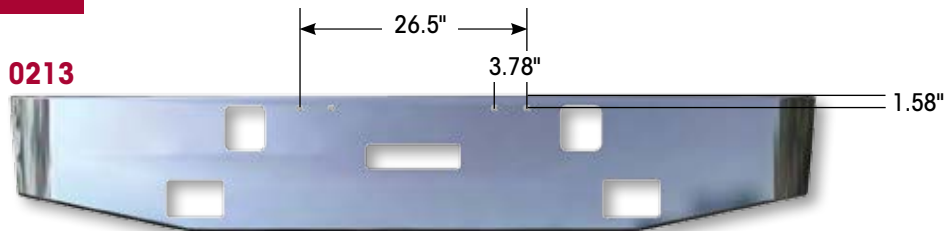

PART NUMBER	MATERIAL / FINISH	EXCLUSIVE	GAUGE	STYLE	LIGHT	CENTER STEP	VENT	TOW	MOUNTING ONLY	VORAD
0216	Chrome		10	16" Taper		X		X		
0216SQ	Chrome		10	18" TSQ		X		X		
0213	Chrome		10	16" Taper	2 Square	X		X		
0213SQ	Chrome		10	18" TSQ	2 Square	X		X		
0216SSCSQ	AERO CLAD®		10	18" TSQ SSC		X		X		
0213SSCSQ	AERO CLAD		10	18" TSQ SSC	2 Square	X		X		
7216SSC	AERO CLAD		7	16" Taper SSC		X		X		
7213SSC	AERO CLAD		7	16" Taper SSC	2 Square	X		X		
7216	Chrome		7	16" Taper		X		X		
7216SQ	Chrome		7	18" TSQ		X		X		
7213	Chrome		7	16" Taper	2 Square	X		X		
7213SQ12	Chrome		7	12" Taper	2 Square	X		X		
7213SQ	Chrome		7	18" TSQ	2 Square	X		X		



FREIGHTLINER

FLD-CLASSIC cont.

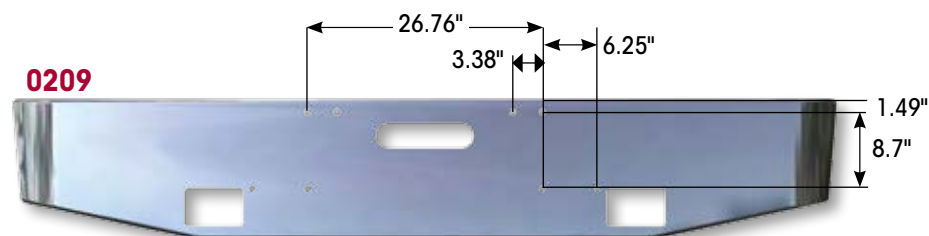

PART NUMBER	MATERIAL / FINISH	EXCLUSIVE	GAUGE	STYLE	LIGHT	CENTER STEP	VENT	TOW	MOUNTING ONLY	VORAD
0223SQ	Chrome		10	18" TSQ					X	
0209NL	Chrome		10	16" Taper				X		
0267SQ12	Chrome		10	12" TSQ				X		
0209NLSQ	Chrome		10	18" TSQ				X		
0262SQ	Chrome		10	18" TSQ	9 Oval			X		
0263SQ	Chrome		10	18" TSQ	15 Round			X		
0283SQ18	Chrome		10	18" Box				X		
0207	Chrome		10	16" Taper		X		X		
0207SQ	Chrome		10	18" TSQ		X		X		
0209	Chrome		10	16" Taper	2 Square			X		
0209SQ	Chrome		10	18" TSQ	2 Square			X		
0251SSCSQ	AERO CLAD®		10	18" TSQ SSC				X		
0250SSCSQ	AERO CLAD		10	18" TSQ SSC	2 Square			X		
0209NLSTQ	Stainless		10	18" TSQ SSC				X		
0209STQ	Stainless		10	18" TSQ SSC	2 Square			X		
7251SSC	AERO CLAD		7	16" Taper SSC				X		
7250SSC	AERO CLAD		7	16" Taper SSC	2 Square			X		
7209NL	Chrome		7	16" Taper				X		
7209NLSQ	Chrome		7	18" TSQ				X		
7209	Chrome		7	16" Taper	2 Square			X		
7209SQ	Chrome		7	18" TSQ	2 Square			X		

FREIGHTLINER COLUMBIA

Introducing the industry's first three-piece bumper combining **HENDRICKSON AERO BRIGHT®** and steel-chrome technology

Part Numbers

HDR 0292BRT *Face mount 2004 - 2007 models*

HDR 0293BRT *Flange mount 2004 and older models*

HDR 0292P *Steel-chrome center section - face mount
2004 - 2007 models*

HDR 0293P *Steel-chrome center section - 2004 and older models*

HDR 0293BRTL *Driver side end cap - all models*

HDR 0293BRTR *Passenger side end cap - all models*



Features and Benefits

- Brilliant "chrome-like" mirror finish
- Easy installation to factory mounts
- OEM styling and serviceability
- High-impact TPO resin end caps



**HENDRICKSON
AERO BRIGHT®**



Columbia 3-piece bumper now available with a ready-to-paint e-coat finish

Part Numbers

FF0292C *Center section with E-coat finish only*

0292L *Driver side end cap molded in black only*

0292R *Passenger side end cap molded in black only*



Features and Benefits

- Easy installation to factory mounts
- High-impact TPO resin end caps
- E-coat finish
- Ready for top coat
- Sturdy, robust
- One-year limited warranty*



* Visit our website at www.hendricksonbumper.com or call 800.356.6737 for complete warranty terms, conditions and limitations.



FREIGHTLINER CASCADIA®

Part Numbers

0256SSC* *Bumper kit with road light openings*

0256NLSSC* *Stainless clad aluminum*

**Kit includes hardware needed to replace OEM plastic bumper.*

0257SSC* *Primed aluminum*

0257NLSSC* *Stainless clad aluminum*

**Assembly when replacing existing AERO CLAD bumper.*

See chart below for complete details on these parts.

OEM Databook AERO CLAD® Option: 556-105 — Now Available

AERO CLAD® Stainless Steel Clad Aluminum Bumper



Please refer to page 31 for air dams



Features and Benefits

- Durable, bright mirrored finish
- Finish 10 times thicker than chrome
- Resists corrosion
- Resists cracking, pitting, peeling and fading
- Increased ground clearance
- Lightweight for better fuel economy
- Minor abrasions can be buffed
- Full five-year limited warranty*

** Visit our website at www.hendricksonbumper.com or call 800.356.6737 for complete warranty terms, conditions and limitations.*

	PART NUMBER	DRIVE LIGHT OPENING	DRIVE LIGHT BRACKET	MOUNTING BRACKET	INTERMEDIATE BRACKETS	PLASTIC TRIM
Bumper kit to replace current OEM plastic bumper	0256SSC	X	X (Assembled)	X (Assembled)	X	X
	0256NLSSC			X (Assembled)	X	X
Bumper assembly to replace existing AERO CLAD bumper	0257SSC	X	X (Assembled)	X (Assembled)		
	0257NLSSC			X (Assembled)		



INTERNATIONAL®

9200/9400

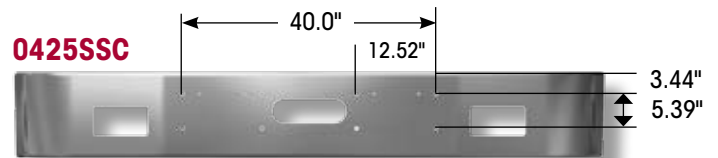
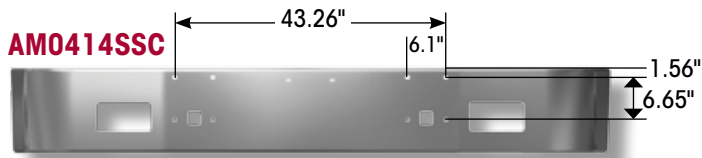

PART NUMBER	MATERIAL / FINISH	EXCLUSIVE	GAUGE	STYLE	LIGHT	CENTER STEP	VENT	TOW	MOUNTING ONLY	VORAD
AM0414SSC*	AERO CLAD®	Intl	10	9400 Series	X			X		
AM0413SSC*	AERO CLAD	Intl	10	9200 Series	X			X		
0425SSC**	AERO CLAD		10	12" Set Back SSC	2 Square	X				

*Fits 1996 year and older

**Fits 1996 year and newer

Vision 98



PART NUMBER	MATERIAL / FINISH	EXCLUSIVE	GAUGE	STYLE	LIGHT	CENTER STEP	VENT	TOW	MOUNTING ONLY	VORAD
AM0420SSC	AERO CLAD®		10	12" Set Back SSC		X		X		
AM0442SSC	AERO CLAD		10	12" Set Back SSC		X		X		X
AM0420X	Aluminum Primed		10	12" Set Back		X		X		

5000

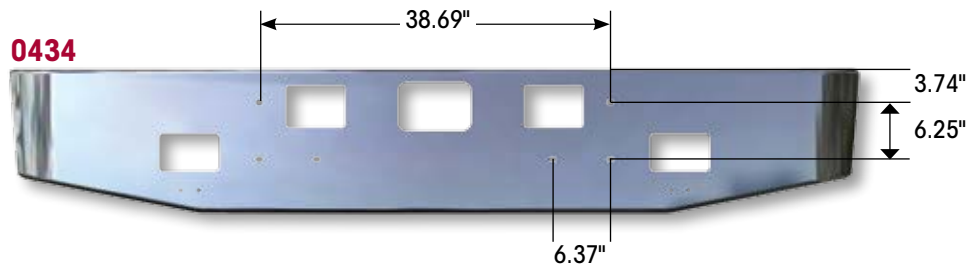

5900 Conventional Series

PART NUMBER	MATERIAL / FINISH	EXCLUSIVE	GAUGE	STYLE	LIGHT	CENTER STEP	VENT	TOW	MOUNTING ONLY	VORAD
0434	Chrome		10	16" Taper	2 Square	X		X		
0434SQ	Chrome		10	18" TSQ	2 Square	X		X		



INTERNATIONAL®

7000

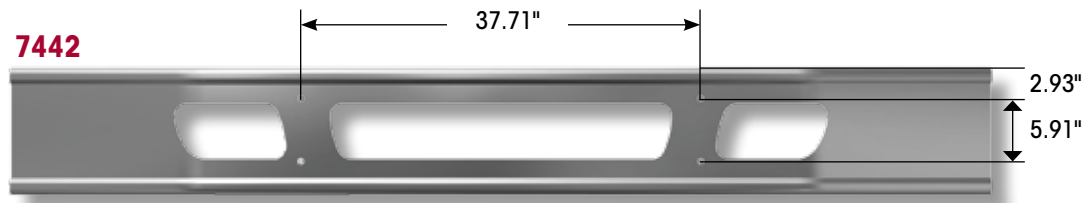

PART NUMBER	MATERIAL / FINISH	EXCLUSIVE	GAUGE	STYLE	LIGHT	CENTER STEP	VENT	TOW	MOUNTING ONLY	VORAD
7442	Chrome		7	12" Set Forward			X	X		
7445	Chrome		7	12" Set Back			X	X		
7442B	Steel Primed		7	12" Set Forward			X	X		
7445B	Steel Primed		7	12" Set Back			X	X		
7442SSC	AERO CLAD®		7	12" Set Forward			X	X		
7445SSC	AERO CLAD		7	12" Set Back			X	X		

Will fit:

- 7300 - October 2001 and newer
- 7400 - July 2001 and newer
- 7500 - July 2001 and newer
- 7600 - April 2002 and newer

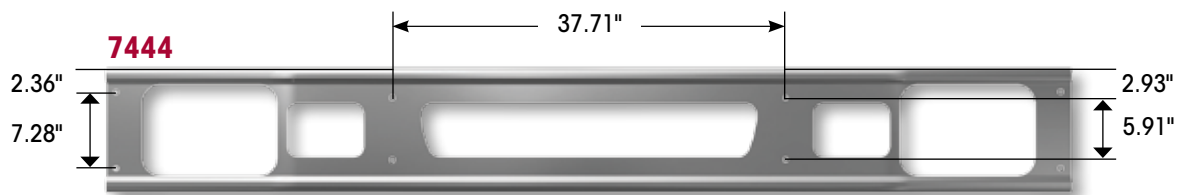

PART NUMBER	MATERIAL / FINISH	EXCLUSIVE	GAUGE	STYLE	LIGHT	CENTER STEP	VENT	TOW	MOUNTING ONLY	VORAD
7444	Chrome		7	12" Set Forward	X		X	X		
7444B	Steel Primed		7	12" Set Forward	X		X	X		
7444SSC	AERO CLAD		7	12" Set Forward	X		X	X		

Will fit:

- 7600 - April 2002 and newer
- 7700 - December 2003 and newer

INTERNATIONAL®

9000

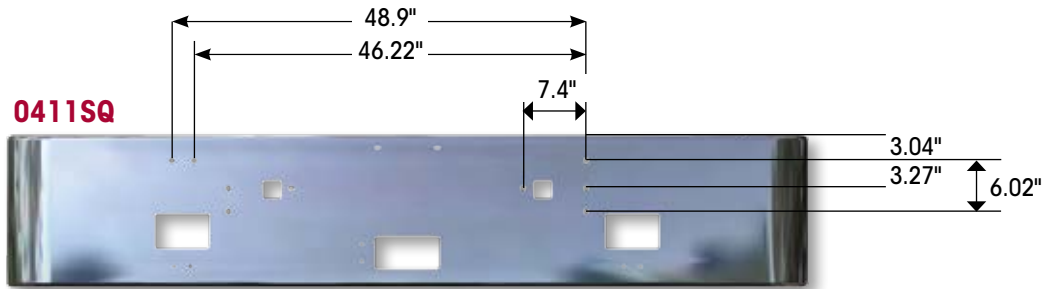

9370 Conventional Series

PART NUMBER	MATERIAL / FINISH	EXCLUSIVE	GAUGE	STYLE	LIGHT	CENTER STEP	VENT	TOW	MOUNTING ONLY	VORAD
0416SQ	Chrome		10	18" TSQ				X		
0417SQ	Chrome		10	18" TSQ	9 Oval			X		
0410	Chrome		10	16" Taper		X		X		
0410SQ	Chrome		10	18" TSQ		X		X		
0411	Chrome		10	16" Taper	2 Square	X		X		
0411SQ	Chrome		10	18" TSQ	2 Square	X		X		
7411	Chrome		7	16" Taper	2 Square	X		X		

9900

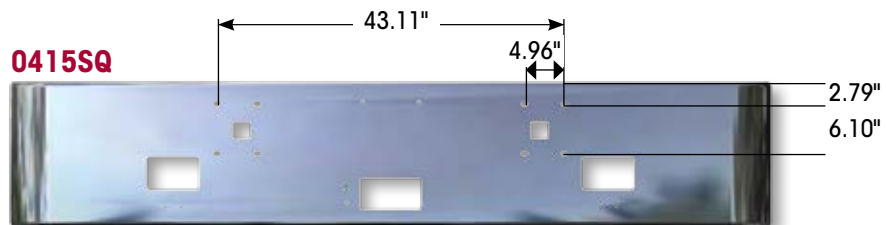

PART NUMBER	MATERIAL / FINISH	EXCLUSIVE	GAUGE	STYLE	LIGHT	CENTER STEP	VENT	TOW	MOUNTING ONLY	VORAD
0415NL	Chrome		10	16" Taper		X		X		
0415NLSQ	Chrome		10	18" TSQ		X		X		
0415	Chrome		10	16" Taper	2 Square	X		X		
0415SQ	Chrome		10	18" TSQ	2 Square	X		X		
0415SSCSQ	AERO CLAD		10	18" TSQ	2 Square	X		X		
0415STQ	Stainless		10	18" TSQ	2 Square	X		X		
0425SQ*	Chrome		10	18" TSQ				X		

NOTE: AERO CLAD® Texas Square requires separate purchase of stiffener brackets, P/N 3523291C1 LH and 3523292C1 RH.

*Fits 1996 year and newer



INTERNATIONAL® ProStar®

Introducing the industry's first **AERO GUARD™** bumper

International Exclusive

Part Numbers

Any year model

0450AG	Two-piece Bumper Kit Molded in Dark Shadow Gray with Universal Mounting Brackets
0450AGV*	Two-piece Bumper Kit Molded in Dark Shadow Gray with Universal Mounting Brackets
0450AGL	Driver-side Section Molded in Dark Shadow Gray
0450AGR	Passenger-side Section Molded in Dark Shadow Gray
0450AGVL*	Driver-side Section Molded in Dark Shadow Gray
0450AGVR*	Passenger-side Section Molded in Dark Shadow Gray
602124XT	New Universal Tilt Mounting Bracket for AERO GUARD™ bumper (0450 models only)

*Collision radar system compatible

2010 and older models only

0449AG	Two-piece Bumper Kit Molded in Black
0449AGV	Two-piece Bumper Kit Molded in Black (with Vorad)
0449AGR	Passenger-side Section Molded in Color
0449AGL	Driver-side Section Molded in Color

H AERO GUARD™ Injection Molded Resin Bumper



Features and Benefits

- Cold impact durability to -30°F
- Lightweight design — molded structural design with fewer brackets and components
- Up to 3.75 inches of increased ground clearance over OEM bumper
- Molded in dark shadow gray — can be painted to color of choice
- Improved cooling air flow capacity
- Simple, two-piece design for serviceability
- AERO GUARD bumper assembly is tilt mount compatible
- 100% recyclable TPO



Introducing the latest Hendrickson ProStar® **AERO CLAD®** bumper

Part Numbers

Pre 2010 (Tilt Mount)

AM0449X	Primed Aluminum
AM0449SSC	Stainless Clad Aluminum

2010 and newer (Fixed Mount)

AM0450X*	Primed Aluminum
AM0450SSC*	Stainless Clad Aluminum

*Mounting brackets/braces needed from Navistar, Inc. — same as OEM Part 6086846C92

*Top fillers included with bumper. Air dam sold separately.

H AERO CLAD® Stainless Steel Clad Aluminum Bumper

International Exclusive



Please refer to page 31 for air dams

Features and Benefits

- Durable, bright mirrored finish
- Finish 10 times thicker than chrome
- Resists corrosion
- Resists cracking, pitting, peeling and fading
- High ground clearance
- Lightweight for better fuel economy
- Minor abrasions can be buffed
- Full five-year limited warranty*

* Visit our website at www.hendricksonbumper.com or call 800.356.6737 for complete warranty terms, conditions and limitations.



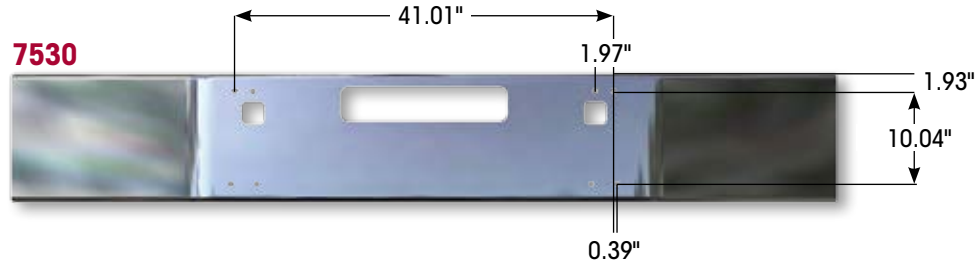

CONVENTIONAL WITH 7-INCH BREAK-BACK: 1986 TO 2004 MODELS

PART NUMBER	MATERIAL / FINISH	EXCLUSIVE	GAUGE	STYLE	LIGHT	CENTER STEP	VENT	TOW	MOUNTING ONLY	VORAD
0539	Chrome		10	14" Open End				X		
0530	Chrome		10	14" Open End			X	X		
0540	Chrome		10	14" Taper			X	X		
0531	Chrome		10	14" Open End	2 Square		X	X		
0543	Chrome		10	14" Taper	2 Square		X	X		
0530SSC	AERO CLAD®			14" Open End			X	X		
7530	Chrome		7	14" Open End			X	X		
7540	Chrome		7	14" Taper			X	X		
7534	Chrome		7	14" Open End			X	External Tow Holes		
7542	Chrome		7	14" Taper			X	External Tow Holes		
7531	Chrome		7	14" Open End	2 Square		X	X		
7543	Chrome		7	14" Taper	2 Square		X	X		
7533	Chrome		7	14" Open End	2 Square		X	External Tow Holes		
7544	Chrome		7	14" Taper	2 Square		X	External Tow Holes		

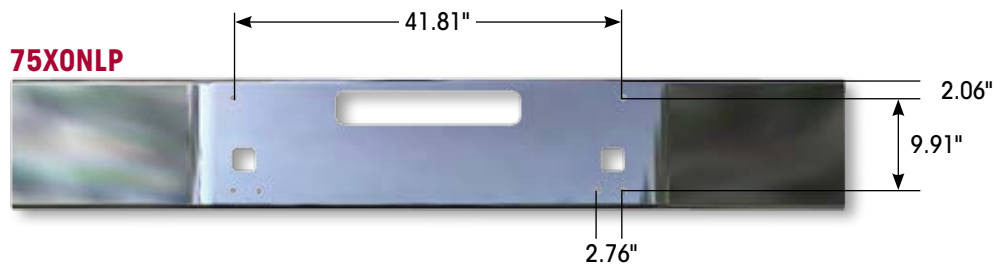

CONVENTIONAL SET BACK AXLE: 2005 AND NEWER COMMON CHASSIS

PART NUMBER	MATERIAL / FINISH	EXCLUSIVE	GAUGE	STYLE	LIGHT	CENTER STEP	VENT	TOW	MOUNTING ONLY	VORAD
75X0NLP	Chrome	KW	7	14" Open End			X	X		
75X2NLP	Chrome	KW	7	14" Taper			X	X		
75X3NLP	Chrome	KW	7	14" Taper			X	External Tow Holes		
75X0P	Chrome	KW	7	14" Open End	2 Square		X	X		
75X2P	Chrome	KW	7	14" Taper	2 Square		X	X		
75X2NLPOLP	Aluminum Polished		7	14" Taper			X	X		
75X2POLP	Aluminum Polished		7	14" Taper	2 Square		X	X		

KENWORTH

W900L

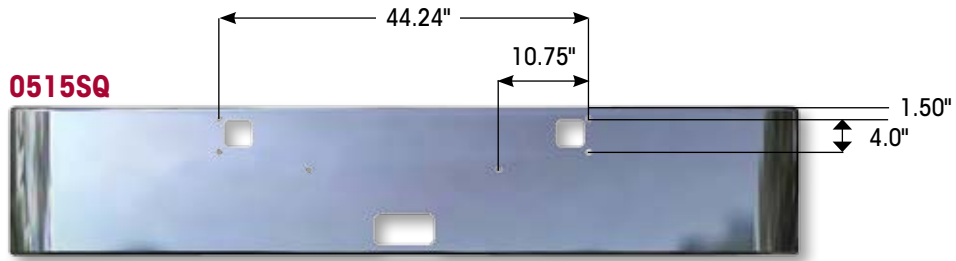

CONVENTIONAL: 1982 AND NEWER

PART NUMBER	MATERIAL / FINISH	EXCLUSIVE	GAUGE	STYLE	LIGHT	CENTER STEP	VENT	TOW	MOUNTING ONLY	VORAD
0522SQ	Chrome		10	18" TSQ				X		
0574SQ	Chrome		10	18" TSQ	9 Oval			X		
0584SQ	Chrome		10	18" TSQ	15 Round			X		
0521SQ	Chrome		10	20" BOX				X		
0515IN18	Chrome		10	18" Taper		X		X		
0515SQ	Chrome		10	18" TSQ		X		X		
0514SQ	Chrome		10	18" TSQ	2 Square	X		X		
0515STQ	Stainless Steel		10	18" TSQ		X		X		
7522	Chrome		7	16" Taper				X		
7522SQ	Chrome		7	18" TSQ				X		
7515	Chrome		7	16" Taper		X		X		
7515SQ	Chrome		7	18" TSQ		X		X		
7514	Chrome		7	16" Taper	2 Square	X		X		
7514SQ	Chrome		7	18" TSQ	2 Square	X		X		



KENWORTH

W900B

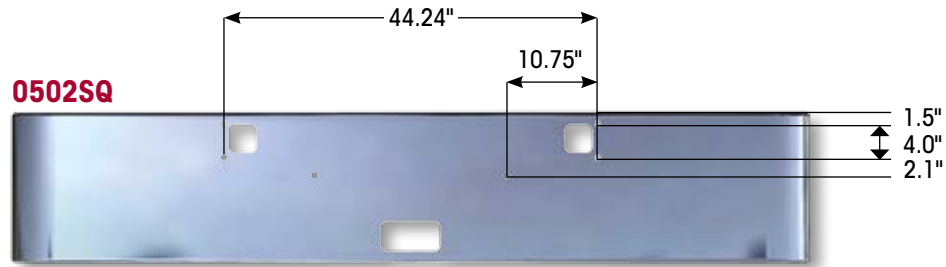

SEVERE DUTY

PART NUMBER	MATERIAL / FINISH	EXCLUSIVE	GAUGE	STYLE	LIGHT	CENTER STEP	VENT	TOW	MOUNTING ONLY	VORAD
0512SQ	Chrome		10	18" TSQ				X		
0502SQ	Chrome		10	18" TSQ		X		X		
0502	Chrome		10	16" Taper		X		X		
0503SQ	Chrome		10	18" TSQ	2 Square	X		X		
0503	Chrome		10	16" Taper	2 Square	X		X		
7512SQ	Chrome		7	18" TSQ				X		
7525	Chrome		7	16" Taper		X		X		
7502SQ	Chrome		7	18" TSQ		X		X		
7502	Chrome		7	16" Taper		X		X		
7503	Chrome		7	16" Taper	2 Square	X		X		

W900S

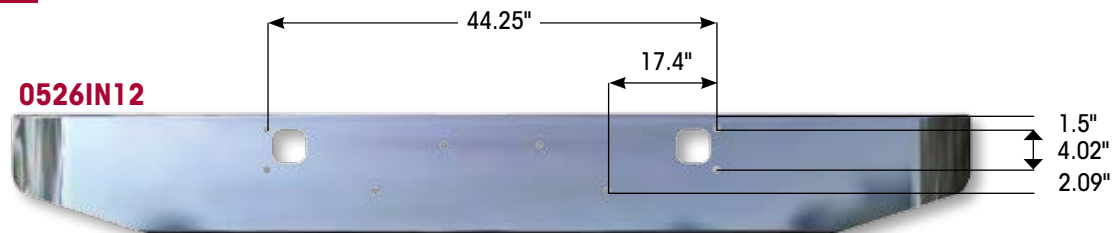

CONVENTIONAL: 1989 AND NEWER

PART NUMBER	MATERIAL / FINISH	EXCLUSIVE	GAUGE	STYLE	LIGHT	CENTER STEP	VENT	TOW	MOUNTING ONLY	VORAD
0526IN12	Chrome		10	12" Taper				X		

KENWORTH

T600B

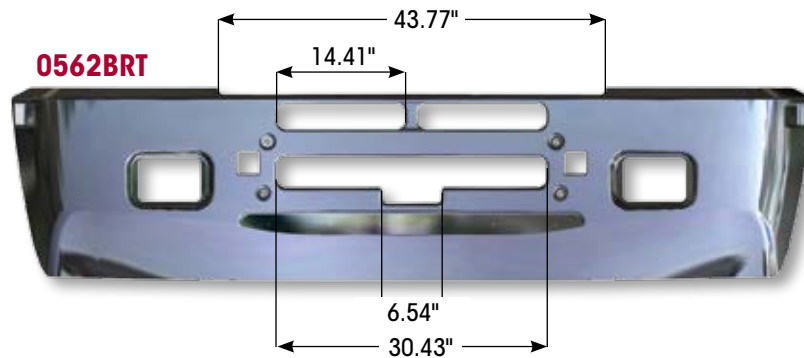

CONVENTIONAL: 1989 AND NEWER

PART NUMBER	MATERIAL / FINISH	EXCLUSIVE	GAUGE	STYLE	LIGHT	CENTER STEP	VENT	TOW	MOUNTING ONLY	VORAD
0562SSC	AERO CLAD®		10	12" Set Back			X	X		
0562NLBRT	HENDRICKSON AERO BRIGHT®		10	12" Set Back			X	X		
0562BRT	HENDRICKSON AERO BRIGHT		10	12" Set Back	2 Square		X	X		

T300

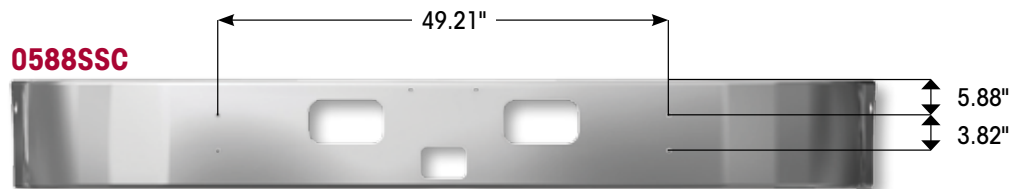

PART NUMBER	MATERIAL / FINISH	EXCLUSIVE	GAUGE	STYLE	LIGHT	CENTER STEP	VENT	TOW	MOUNTING ONLY	VORAD
0589SSC	AERO CLAD		10	12" Set Forward				X		
0588SSC	AERO CLAD		10	12" Set Forward		X		X		
7589B	Steel Primed		7	12" Set Forward				X		

KENWORTH T660

Introducing the latest Hendrickson All Makes **AERO CLAD®** bumper

Providing strength and durability without sacrificing weight, Hendrickson AERO CLAD® for T660 has the right combination to add distinctive styling to any fleet.

AERO CLAD® Stainless Steel Clad Aluminum Bumper



Please refer to page 31 for air dams

PART NUMBER	DRIVE LIGHT OPENING	VORAD OPENING	CENTER OPENING	TOW OPENING
05R1NLSSC			X	X
05R1SSC	X		X	X
05R1NLVSSC		X	X	X
05R1VSSC	X	X	X	X

*All models include rock screen in vent openings.
Air dam assembly: N33-6030 (Driver side), N33-6030R (Passenger side)*



AERO CLAD Features and Benefits

- Durable, bright mirrored finish
- Finish 10 times thicker than chrome
- Resists corrosion
- Resists cracking, pitting, peeling and fading
- Lightweight for better fuel economy
- High ground clearance
- Environmentally green alternative to chrome plating
- Minor abrasions can be buffed
- Full five-year limited warranty*

** Visit our website at www.hendricksonbumper.com or call 800.356.6737 for complete warranty terms, conditions and limitations.*



0649SSC

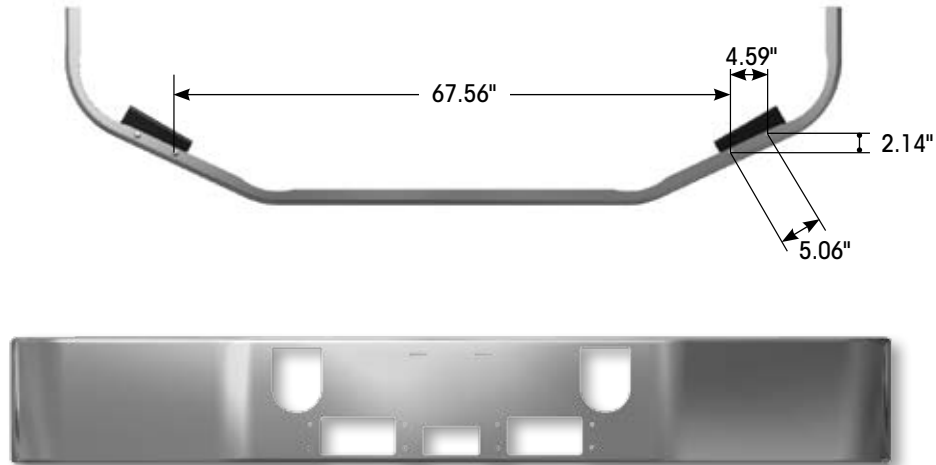

PART NUMBER	MATERIAL / FINISH	EXCLUSIVE	GAUGE	STYLE	LIGHT	CENTER STEP	VENT	TOW	MOUNTING ONLY	VORAD
0649SSC	AERO CLAD®	Mack		Set Back Axle	X	X		X		
0649B	Steel Primed	Mack	10	Set Back Axle	X	X		X		
0648SSC	AERO CLAD	Mack		Set Back Axle		X		X		
0648B	Steel Primed	Mack	10	Set Back Axle		X		X		

0637SSC



PART NUMBER	MATERIAL / FINISH	EXCLUSIVE	GAUGE	STYLE	LIGHT	CENTER STEP	VENT	TOW	MOUNTING ONLY	VORAD
0636SSC	AERO CLAD®	Mack		Set Forward Axle		X		X		
0636B	Steel Primed	Mack	10	Set Forward Axle		X		X		
0637SSC	AERO CLAD	Mack		Set Forward Axle	X	X		X		
0637B	Steel Primed	Mack	10	Set Forward Axle	X	X		X		

MACK

R/U Model

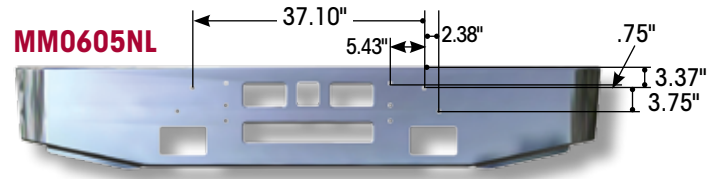
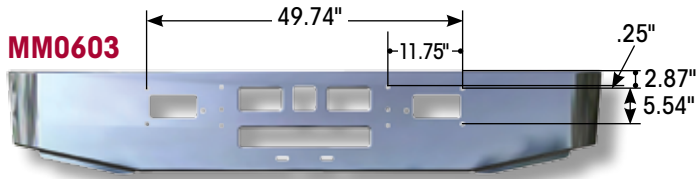

PART NUMBER	MATERIAL / FINISH	EXCLUSIVE	GAUGE	STYLE	LIGHT	CENTER STEP	VENT	TOW	MOUNTING ONLY	VORAD
MM0603	Chrome	Mack	10	R Model			X	X		
0603	Chrome		10	R Model			X	X		
0603SQ	Chrome	Mack	10	R Model			X	X		
MM0605NL	Chrome	Mack	10	U Model			X	X		
7605NL	Chrome	Mack	7	U Model			X	X		

RD Model

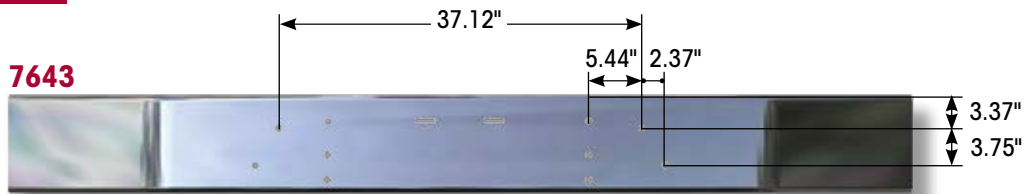

PART NUMBER	MATERIAL / FINISH	EXCLUSIVE	GAUGE	STYLE	LIGHT	CENTER STEP	VENT	TOW	MOUNTING ONLY	VORAD
7643*	Chrome		7	Set Back Axle						
0643SSC*	AERO CLAD®			Set Back Axle						

*With cow catcher holes

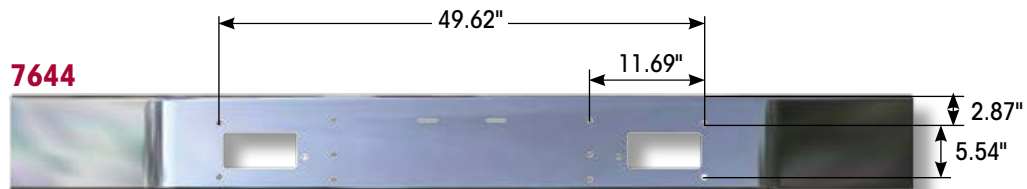

SET BACK AXLE WITH TOW HOLES AND COW CATCHER HOLES

PART NUMBER	MATERIAL / FINISH	EXCLUSIVE	GAUGE	STYLE	LIGHT	CENTER STEP	VENT	TOW	MOUNTING ONLY	VORAD
7644*	Chrome		7	10" Open End				X		
0644SSC	AERO CLAD			10" Open End						

*With cow catcher holes



MACK

CL Model

0650SSC



PART NUMBER	MATERIAL / FINISH	EXCLUSIVE	GAUGE	STYLE	LIGHT	CENTER STEP	VENT	TOW	MOUNTING ONLY	VORAD
0650SSC	AERO CLAD®			Set Back Axle		X				
0651SSC	AERO CLAD			Set Back Axle				X		

DM Model

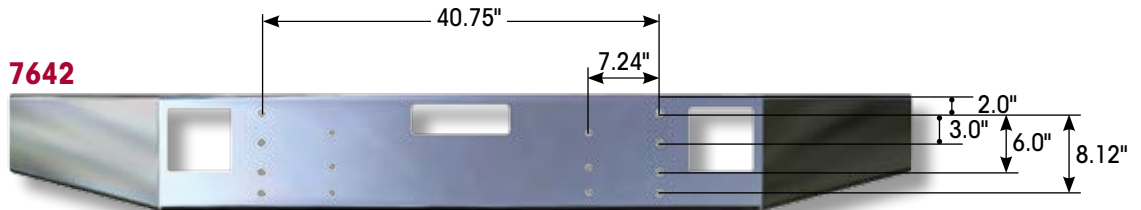

SET BACK AXLE

PART NUMBER	MATERIAL / FINISH	EXCLUSIVE	GAUGE	STYLE	LIGHT	CENTER STEP	VENT	TOW	MOUNTING ONLY	VORAD
7642	Chrome			10" Open End			X	X		

Granite® Corporate Bumper

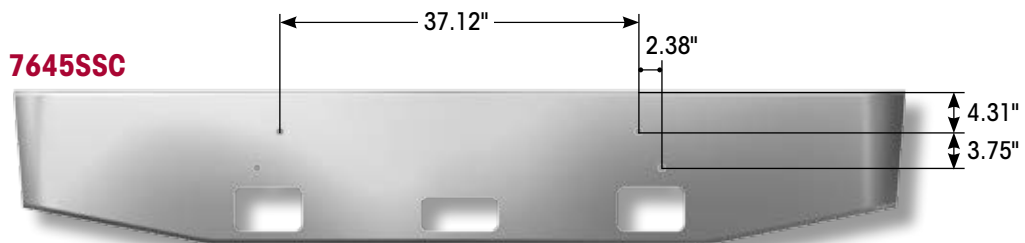

PART NUMBER	MATERIAL / FINISH	EXCLUSIVE	GAUGE	STYLE	LIGHT	CENTER STEP	VENT	TOW	MOUNTING ONLY	VORAD
7645SSC	AERO CLAD			16" Taper SSC		X		X		

MACK Pinnacle™ CXU/Vision CX

Part Numbers

MM0619SSC CXU Pinnacle™ with Drive Light Opening

MM0619NLSSC CXU Pinnacle without Drive Light Opening

7659SSC CX Vision with Drive Light Opening

7658SSC CX Vision without Drive Light Opening



AERO CLAD Features and Benefits

- Durable, bright mirrored finish
- Finish 10 times thicker than chrome
- Resists corrosion
- Resists cracking, pitting, peeling and fading
- Lightweight for better fuel economy
- Minor abrasions can be buffed
- Full five-year limited warranty*

* Visit our website at www.hendricksonbumper.com or call 800.356.6737 for complete warranty terms, conditions and limitations.



MACK CH

Part Number

0649BRT Face mount 2004 - 2007 models



Features and Benefits

- Brilliant "chrome-like" mirror finish
- Easy installation to factory mounts
- OEM styling and serviceability
- High-impact TPO resin end caps



MACK CH Set Back Axle

OEM PART NUMBER	DESCRIPTION	HENDRICKSON ALL MAKES	DESCRIPTION
24QL5106,7,8M	R,L,C	0649BRT	HENDRICKSON AERO BRIGHT
		0649BLK	Black Paintable



PETERBILT

Model 352/359

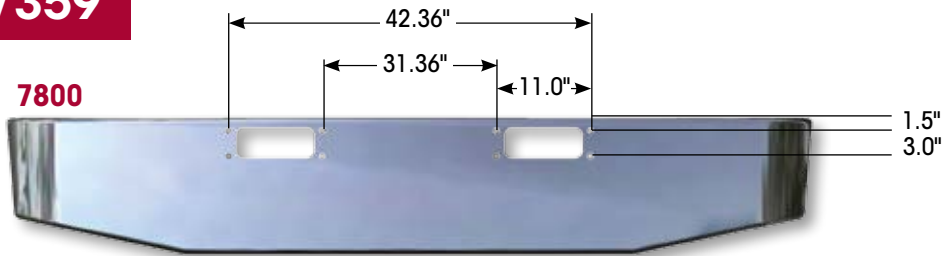

Peterbilt conventional and cabover models 352 and 359 (Towholes Only)

PART NUMBER	MATERIAL / FINISH	EXCLUSIVE	GAUGE	STYLE	LIGHT	CENTER STEP	VENT	TOW	MOUNTING ONLY	VORAD
0800SQ	Chrome		10	18" TSQ						
7800P	Chrome		7	16" Taper				X		

Model 385

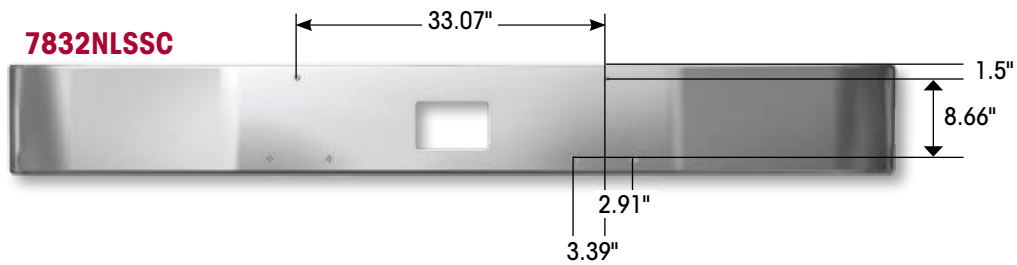

Peterbilt conventional cab model 385

PART NUMBER	MATERIAL / FINISH	EXCLUSIVE	GAUGE	STYLE	LIGHT	CENTER STEP	VENT	TOW	MOUNTING ONLY	VORAD
7832NLSSC	AERO CLAD®		7	12" Set Back SSC				X		
7832SSC	AERO CLAD		7	12" Set Back SSC	2 Square			X		

Model 330

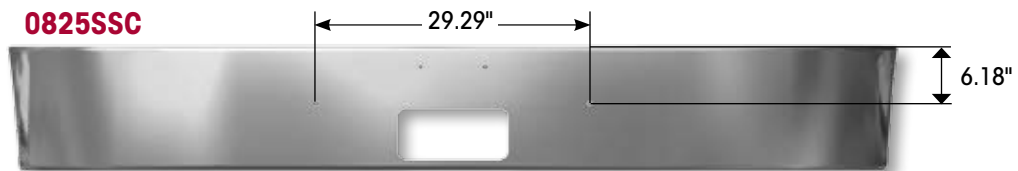

PART NUMBER	MATERIAL / FINISH	EXCLUSIVE	GAUGE	STYLE	LIGHT	CENTER STEP	VENT	TOW	MOUNTING ONLY	VORAD
0826SSC	AERO CLAD	PB	10	12" Set Forward SSC, 16K				X		
0825SSC	AERO CLAD	PB	10	12" Set Forward SSC, 12K				X		

PETERBILT

Model 357/378/379

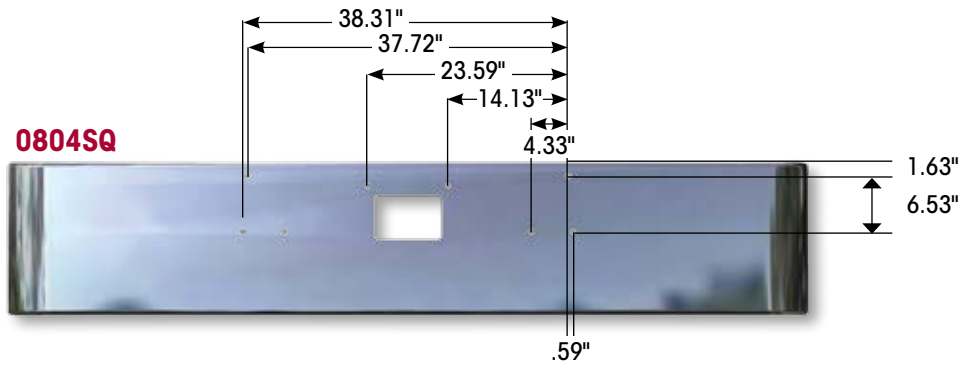

PART NUMBER	MATERIAL / FINISH	EXCLUSIVE	GAUGE	STYLE	LIGHT	CENTER STEP	VENT	TOW	MOUNTING ONLY	VORAD
0804NTSQ	Chrome		10	18" TSQ					X	
0804IN12	Chrome		10	12" Taper				X		
0804	Chrome		10	16" Taper				X		
0804SQ16	Chrome		10	16" TSQ				X		
0804SQ	Chrome		10	18" TSQ				X		
0844SQ	Chrome		10	18" TSQ	4 Oval			X		
0864SQ	Chrome		10	18" TSQ	6 Oval			X		
0874SQ	Chrome		10	18" TSQ	9 Oval			X		
0884SQ	Chrome		10	18" TSQ	15 Round			X		
0807SQ	Chrome		10	18" Box				X		
0887SQ	Chrome		10	18" Box	15 Round			X		
0804SQ20	Chrome		10	20" TSQ				X		
0809SQ20	Chrome		10	18" Box				X		
0894	Chrome		10	16" Taper				External Tow Holes		
0852	Chrome		10	16" Taper	2 Square					X
0805	Chrome		10	16" Taper	2 Square			X		
0805SQ	Chrome		10	18" TSQ	2 Square			X		
0804STQ	Stainless		10	18" TSQ SSS				X		
7804	Chrome		7	16" Taper				X		
7804SQ	Chrome		7	18" TSQ				X		
7884SQ	Chrome		7	18" TSQ	15 Round			X		
7807SQ	Chrome		7	18" Box				X		
7805	Chrome		7	16" Taper	2 Square			X		
7805SQ	Chrome		7	18" TSQ	2 Square			X		
7823IN12B	Steel Primed		7	12" Taper				External Tow Holes & Belly Pan Holes		

PETERBILT

Model 387

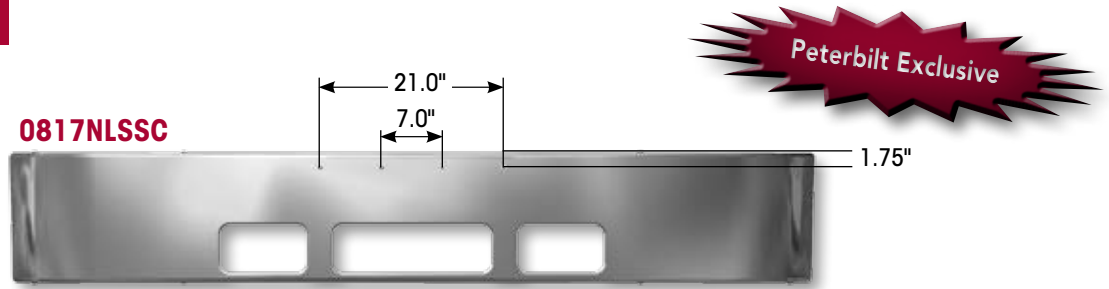

PART NUMBER	MATERIAL / FINISH	EXCLUSIVE	GAUGE	STYLE	LIGHT	CENTER STEP	VENT	TOW	MOUNTING ONLY	VORAD
0817NLSSC	AERO CLAD®	PB	10	18" Set Back SSC		X		X		
0817SSC	AERO CLAD	PB	10	18" Set Back SSC	2 Square	X		X		
0818SSC	AERO CLAD	PB	10	18" Set Back SSC	2 Square	X		X		X

Model 384/386 AERO CLAD®

Introducing the latest Hendrickson All Makes **AERO CLAD** bumper

Part Numbers

MA28U2210-28 (0889SSC) — With Light Cutouts
Direct replacement of OEM Part N71-6061-007

MA28U0210-28 (0889NLSSC) — Without Light Cutouts
Direct replacement of OEM Part N71-6061-005

Two piece air dam available from Peterbilt.
Left side p/n N33-6030 and Right side p/n N33-6030R.



Features and Benefits

- Durable, bright mirrored finish
- Finish 10 times thicker than chrome
- Resists corrosion
- Resists cracking, pitting, peeling and fading

- Lightweight for better fuel economy
- Minor abrasions can be buffed
- Full five-year limited warranty*

* Visit our website at www.hendricksonbumper.com or call 800.356.6737 for complete warranty terms, conditions and limitations.

H AERO CLAD®
Stainless Steel Clad Aluminum Bumper



VOLVO

WIA

0932SSC



PART NUMBER	MATERIAL / FINISH	EXCLUSIVE	GAUGE	STYLE	LIGHT	CENTER STEP	VENT	TOW	MOUNTING ONLY	VORAD
0932SSC	AERO CLAD®			Set Back				X		

VNL

0942BRT



2002 AND OLDER

PART NUMBER	MATERIAL / FINISH	EXCLUSIVE	GAUGE	STYLE	LIGHT	CENTER STEP	VENT	TOW	MOUNTING ONLY	VORAD
0935BRT	HENDRICKSON AERO BRIGHT®			12" Set Back			X	X		
0942BRT	HENDRICKSON AERO BRIGHT			12" Set Back	4 Square		X	X		
0935SSC*	AERO CLAD						X	X		
0940SSC**	AERO CLAD						X	X		

*Mack/Volvo dealers

**All others

VNM

0944SSC



PART NUMBER	MATERIAL / FINISH	EXCLUSIVE	GAUGE	STYLE	LIGHT	CENTER STEP	VENT	TOW	MOUNTING ONLY	VORAD
0944SSC	AERO CLAD			Set Back	X		X	X		

VOLVO VNL 2003 and Newer

Introducing the latest Hendrickson **AERO CLAD®** bumper

Part Numbers

MM0961SSC* with drive light cutouts

MM0961NLSSC* without drive light cutouts

**EXTENDED — to be used with large wheel trim*

MM0960SSC* with drive light cutouts

MM0960NLSSC* without drive light cutouts

0961ADA optional air dam

**BASIC — to be used with small wheel trim*



AERO CLAD Features and Benefits

- Tested fuel efficient design
- Easy installation to factory mounts
- Mounting brackets included
- Durable, bright mirrored finish
- Finish 10 times thicker than chrome
- Resists corrosion
- Lightweight
- Resists cracking, pitting, peeling and fading
- Minor abrasions can be buffed
- Full five-year limited warranty*

** Visit our website at www.hendricksonbumper.com or call 800.356.6737 for complete warranty terms, conditions and limitations.*

AERO CLAD® Stainless Steel Clad Aluminum Bumper



Volvo Exclusive

Introducing the latest Hendrickson VNL bumper

Part Numbers

MM0961B with drive light cutouts

MM0961NLB without drive light cutouts

MM0963B with drive light cutouts and Vorad® opening (as shown)

MM0963NLB without drive light cutouts, with Vorad opening

0961ADA optional air dam

4DD2 OEM databook steel option



Features and Benefits

- Easy installation to factory mounts
- Mounting brackets included
- Corrosion resistant E-coat finish, ready for top coat
- Manufactured with high-impact corrosion resistant steel
- Optional air dam that bolts up to factory installed belly pan can be attached to this bumper
- One-year limited warranty*

** Visit our website at www.hendricksonbumper.com or call 800.356.6737 for complete warranty terms, conditions and limitations.*

STEEL 10-GAUGE BUMPER



Volvo Exclusive

WESTERN STAR

4900 SF

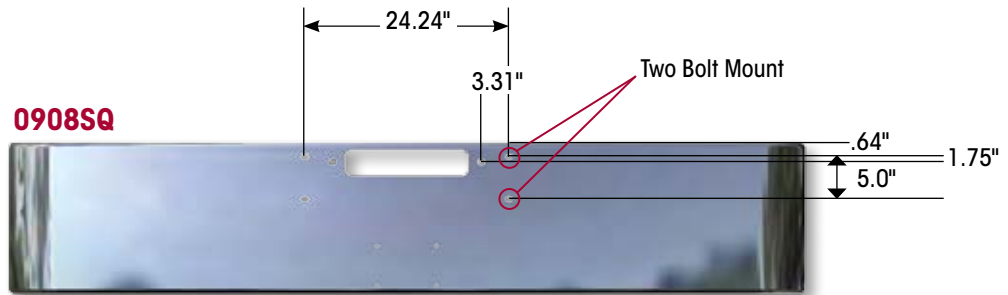

CONVENTIONAL WITH TWO BOLT MOUNT

PART NUMBER	MATERIAL / FINISH	EXCLUSIVE	GAUGE	STYLE	LIGHT	CENTER STEP	VENT	TOW	MOUNTING ONLY	VORAD
0910	Chrome		10	16" Taper					X	
0910SQ	Chrome		10	18" TSQ					X	
0912SQ	Chrome		10	18" TSQ	8 Oval				X	
0911	Chrome		10	16" Taper	2 Square					
0911SQ	Chrome		10	18" TSQ	2 Square					

CORNERSTONE CONVENTIONAL: 1989 AND NEWER WITH THREE BOLT MOUNT

PART NUMBER	MATERIAL / FINISH	EXCLUSIVE	GAUGE	STYLE	LIGHT	CENTER STEP	VENT	TOW	MOUNTING ONLY	VORAD
0909SQ	Chrome		10	18" TSQ					X	
0908	Chrome		10	16" Taper				X		
0908SQ	Chrome		10	18" TSQ				X		
0913SQ	Chrome		10	18" TSQ	8 Oval			X		
0907	Chrome		10	16" Taper	2 Square			X		
0907SQ	Chrome		10	18" TSQ	2 Square			X		
7908	Chrome		7	16" Taper				X		
7907	Chrome		7	16" Taper	2 Square			X		



BUMPER BLANK

0700SQ

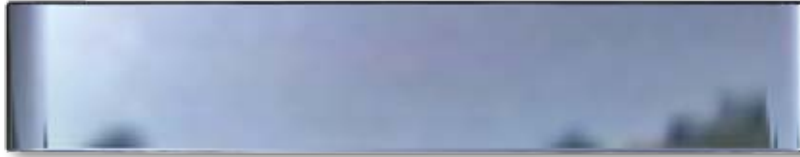

PART NUMBER	MATERIAL / FINISH	EXCLUSIVE	GAUGE	STYLE	LIGHT	CENTER STEP	VENT	TOW	MOUNTING ONLY	VORAD
0700	Chrome		10	16" Taper						
0700SQ	Chrome		10	18" TSQ						



AIR DAMS

NOW AVAILABLE FOR OUR NEWEST **AERO CLAD®** OFFERINGS

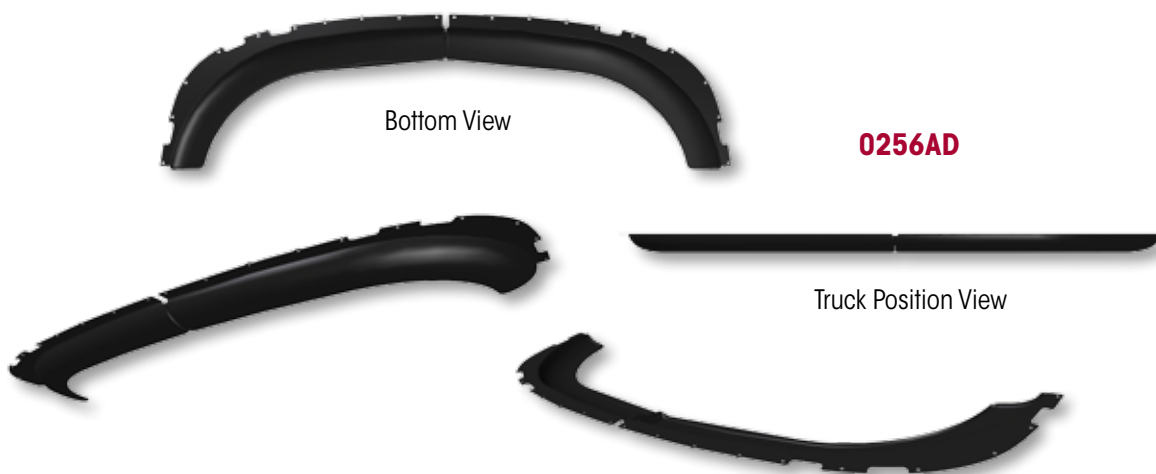

CASCADIA®

PART NUMBER	DESCRIPTION
0256AD*	Full air dam with hardware
0256ADL	Left side with hardware
0256ADR	Right side with hardware

*NOTE: Images shown above are for Air Dam Kit 0256AD

PROSTAR®

PART NUMBER	DESCRIPTION
0449AD	Full air dam with hardware
0449ADL	Left side with hardware
0449ADR	Right side with hardware

T660

PART NUMBER	MATERIAL / FINISH
05R1AD	Full air dam with hardware
05R1ADL	Left side with hardware
05R1ADR	Right side with hardware



DRIVEN TO SUCCEED

Hendrickson Bumper is **DRIVEN** to succeed for you, our customer.

We strive for **dependability** with on time delivery of the components that your customers ordered from you. We know we have a responsibility in helping you maintain the relationships that you and your staff have built with your customers. We also know that the **responsiveness** of our customer service representatives sets us apart from other suppliers and solidifies our commitment to partner with you for the long haul. One of the keys to both yours and Hendrickson's success in the market is **innovation**.

We not only have one of the largest product lineups of any bumper aftermarket supplier, but by utilizing our innovative thinking and concepts, we are also one of the largest OE production line bumper suppliers in North America. By being those things, we at Hendrickson can offer you **value** in the form of our All Makes part numbers. With our employees' years of experience, we have the **expertise** to know that we have the most robust and expansive bumper offerings in the industry and the **integrity** to offer not just sales, but also solutions to your customers needs.



DEPENDABILITY
RESPONSIVENESS
INNOVATION
VALUE
EXPERTISE
INTEGRITY



www.hendricksonbumper.com



www.hendrickson-intl.com

HENDRICKSON

Specialty Products – Bumper and Trim
501 Caton Farm Road
Joliet, IL 60434 USA

800.356.6737
Fax 815.727.4086